



SUNLITE® Multiwall Polycarbonate Sheet

Twinwall 10mm Installation Instructions

Loading Table for Downlift Load

Load (kg/sqm)	Panel max Width (mm)	Purlin Distance (mm)	
		Mid Span	End Span
Up to 100	980	1200	900

Loading Table for high Loads and uplifts

Uplift Load (kg/sqm)	Panel max Width for Rafters (mm)	Purlin Distance (mm)		H Bar Centers (mm)
		Mid Span	End Span	
50	980	1200	900	1000
75	750			770
100	580			600

* In the case of purlin/battens it is possible to keep the full width by adding screws mid sheet to fasten the Sunlite to the structure. Add one screw for medium loads and 2 screws for high loads.

Important Notes Before Installation

- Carefully read all installation instructions before you start.
- Always exercise extreme care when working on a roof.
- Never walk directly on the sheeting, use walking boards along purlins.
- Always wear eye protection when using cutting tool.
- For safety precautions Palram recommends the use of safety mesh for installations above 3m height.

Installation Steps

1. Always install SUNLITE sheets with the ribs running vertically with the direction of the fall.

2. Make sure there is adequate fall of minimum 5 degrees (87mm per 1000mm).
A good fall will aid in keeping the sheets clean.

3. Cut H Joiner alum profiles 50mm shorter than the required length.

4. Cut the SUNLITE® sheet to the required length.

SUNLITE® sheets can be cut with standard wood or metal saw with fine tooth blade. Saw blades designed especially for plastic yield best results. If SUNLITE® width need to be reduced, trim as close as possible to the last rib to obtain better clamping action.

5. Place the first H joiner on the structure. The maximum allowed end overhang is 50mm.

6. When installing on rafters or battens, fasten the first H Joiner 995mm in from the edge of the structure (In the case of rafters, the centre of the 2nd rafter should be installed 995mm from the out side edge of the 1st rafter) Centres of internal rafters/H sections should be 1000mm apart and battens should be a maximum of 1200mm apart.

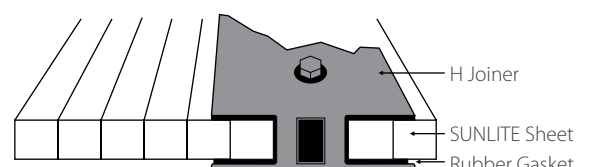
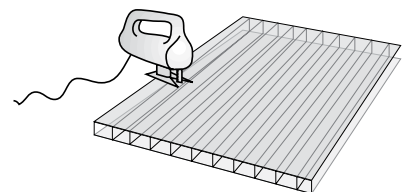
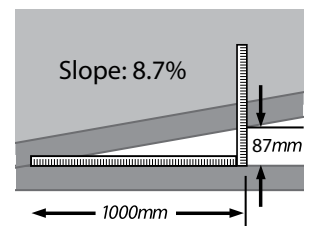



SUNLITE® Multiwall Polycarbonate Sheet

Twinwall 10mm Installation Instructions

7. Screw through the centre of the H section by first drilling a 5mm hole and then using 12 gauge timber or metal screw with a neo. When installing the first and last panels, first attached the F section to the outside of the panel with the leg facing downward.

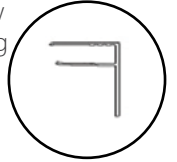

8. Pull the protective film back on the sides of the sheet and place the rubber gasket* on both sides of the sheet to be inserted into the H Joiner. Then use either the F section (Barge ends) or the next H joiner on the side away from the secured H joiner. Insert this section on to the sheet and into the secured H joiner by tapping it in with a rubber mallet than secure the unsecured section as before.

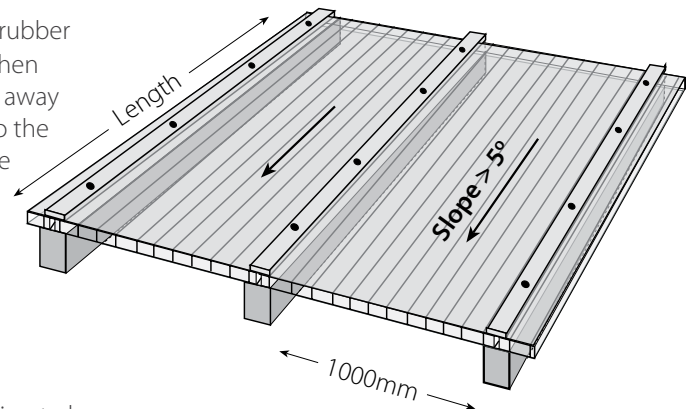

* Not required with F section

9. Repeat steps 6-8 until all sheets are positioned and finish with F section to barge.

10. Insert the Aluminium End Cap on the bottom sheet end (Both top & bottom if free standing). Do not stop at each glazing bar (This should be continuous if possible). Make sure to join alum sheet end caps at the alum joiner (If necessary) so that the joint is covered by the alum end cap lock.

10. Secure the Alum end Cap by screw fastening the Alum End Cap Lock to the H Joiner Cover. This will prevent End Cap from falling off due to sheet expansion and contraction.

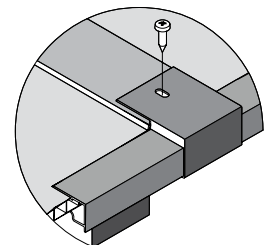
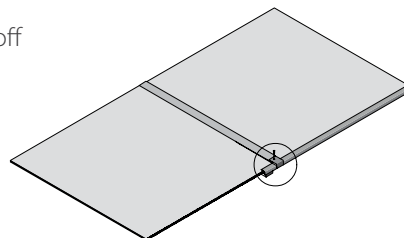

In as much as Palram Industries has no control over the use to which others may put the material, it does not guarantee that the same results as those described herein will be obtained. Each user of the material should make his own tests to determine the material's suitability for his own particular use. Statements concerning possible or suggested uses of the materials described herein are not to be construed as constituting a license under any Palram Industries patent covering such use or as recommendations for use of such materials in the infringement of any patent. Palram Industries or its distributors cannot be held responsible for any losses incurred through incorrect installation of the material. In accordance with our company policy of continual product development you are advised to check with your local Palram Industries supplier to ensure that you have obtained the most up to date information.

