



# SUNGLAZE™

Solid Polycarbonate Standing Seam Architectural System



**SUNGLAZE™** Solid Polycarbonate Standing Seam Architectural System

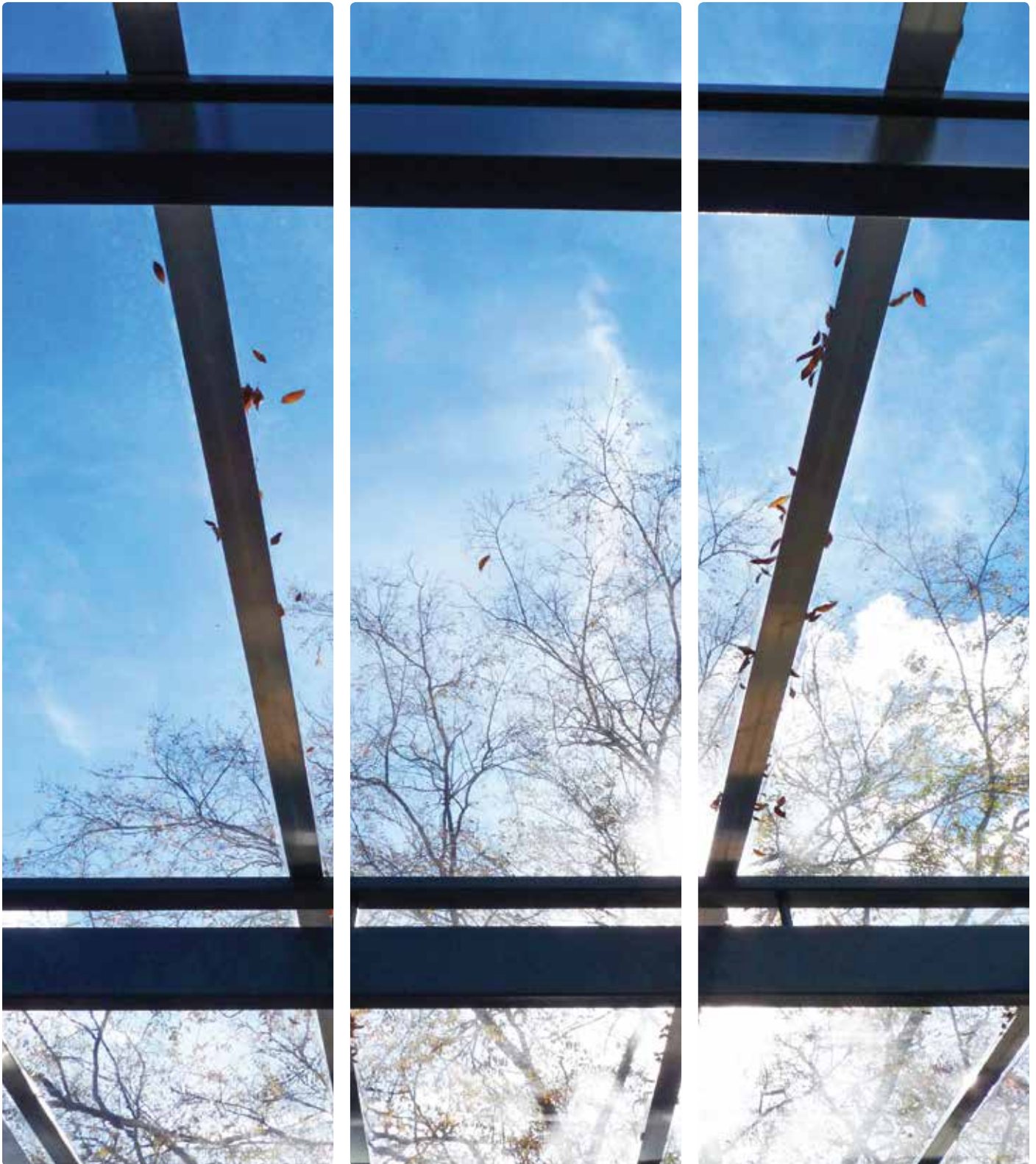

## Content

---

Introduction	2
Main Benefits	2
Applications	2
Panel Types	3
Colors	3
SUNGLAZE™ Projects	4
Thermal Insulation	6
Flammability	6
Typical Physical Properties	7
Acoustic Properties	7
Resistance to UV Radiation	8
Chemical Characteristics	8
System Principles	8
System Components	9
Installation Data	10
Assembly Details	11
Installation Guidelines	12
Manufacturer's Lifetime Warranty	14

---

## Introduction

SUNGLAZE is an architectural system that offers smart design, elegant appearance, versatility, low maintenance and sustainable performance to various architectural challenges. SUNGLAZE incorporates proprietary standing-seam profiling and glazing that enable wide spans and high loading capacity. It can be specified in various lengths to match different structures, including flat and curved designs. SUNGLAZE is easy to fasten; the panels are simply joined by an aluminum profile set that is enclosed at the ends by end-closures. Screws lock the system and fix it to the structure without any penetration through the panels. The Cap-plug completes the assembly, covering the screw head and provides a smooth appearance from above.

## Main Benefits

- ✓ Glass-like clear appearance
- ✓ Standing seam leak-proof performance
- ✓ Free thermal expansion
- ✓ Caulking and silicone free
- ✓ Withstanding high loads
- ✓ Easy, fast and safe installation
- ✓ Minimal maintenance

## Applications

- Architectural projects
- Commercial and retail
- Sports venues roofing
- Covered walkways
- Open markets
- Service stations
- Entrances
- Pool covers

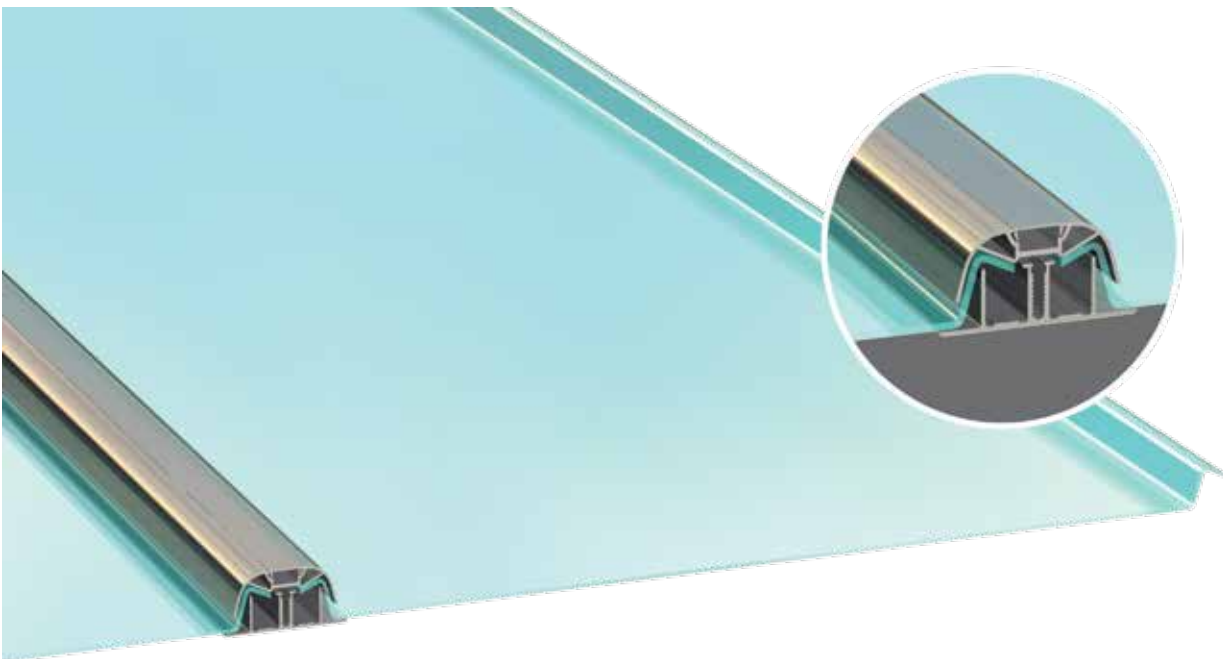

Scan for product  
video overview



## Panel Types

SUNGLAZE solid polycarbonate panels are offered in 3mm and 4mm thickness. Panel width is determined by the system width, 600mm or 800mm. Maximum panel length is 11.9m (typical stock length). Standard SUNGLAZE panels include UV protection on one side (UV protection on both sides is optional for special orders).

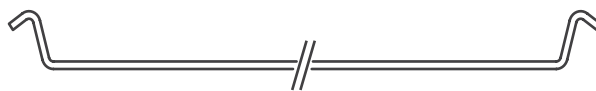

SUNGLAZE™ 3/600 Not stocked in Aust	SUNGLAZE™ 4/600 Not stocked in Aust	SUNGLAZE™ 4/800 Stocked Colour **
Width: 584mm (600mm system)	Width: 585mm (600mm system)	Width: 785mm (800mm system)
Height: 20mm	Height: 21mm	Height: 21mm
Weight: 3.79 Kg/m <sup>2</sup> , (2.20 Kg/m)	Weight: 5.05 Kg/m <sup>2</sup> , (2.94 Kg/m)	Weight: 4.98 Kg/m <sup>2</sup> , (3.90 Kg/m)
Min. cold bending radius: 4m	Min. cold bending radius: 4m	Min. cold bending radius: 4m
System weight: 6.14 Kg/m	System weight: 7.40 Kg/m	System weight: 6.73 Kg/m

## Colors

Color	% Light Transmission ASTM D-1003	%Haze ASTM D-1003	Solar Heat Gain (SHGC) ASTM E-424-71	Shading Coefficient ASTM E-424-71
Clear	90 **	<1	0.87	1.00
	20	<1	0.45	0.52
Bronze	35	<1	0.56	0.64
	50	<1	0.65	0.75
	20 **	<1	0.44	0.51
Solar Grey	35	<1	0.56	0.64
	50	<1	0.65	0.75
White Opal	28	100	0.32	0.37
White Diffuser	80	100	0.87	1.00
Solar Ice	20 **	100	0.39	0.45
Solar Control	20 **	67	0.33	0.36
	20	50	0.41	0.47
Solar Olympic	35 **	35	0.52	0.60
	50	20	0.63	0.73
Smart Green	70	26	0.58	0.67
Smart Blue	50	26	0.57	0.65
Bluish Breeze	70 **	1	0.55	0.63

Note: Special color matches are available upon request, subject to minimum quantity.

### SolarSmart™ - Energy Efficiency

SolarSmart™ products have "smart" tints that break the traditional ratio between light transmission and shading coefficient. They transmit "cool-light" by blocking Infrared energy that causes heat buildup, reduce air-conditioning costs and create a more comfortable ambience required in closed populated spaces.

More energy-saving,  
natural visible light is

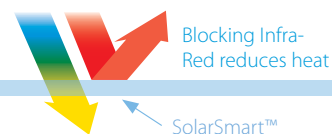

## SUNGLAZE™ Projects

Project: Hangzhou Airport, China | Architect: ZIAD | Application: Canopies - 1,900 sqm | SUNGLAZE™ Type: Solar Olympic 4mm



Project: Australian Federal Police, Tullamarine, Australia | Application: Awning | SUNGLAZE™ Type: Clear 4mm



Project: The Lounge Bar, Melbourne, Australia | Application: Canopy | SUNGLAZE™ Type: Clear 3mm



Project: Private home, Point Cook, Australia | Application: Pergola | SUNGLAZE™ Type: Clear 3mm





## Thermal Insulation

The attached table compares “U” values of glass and SUNGLAZE panels of equivalent thickness. For any given thickness, the “U” value of SUNGLAZE is lower than that of glass. This can result in a significant 6.5-9% reduction in energy expenditure both for heating in winter and air-conditioning during the summer time. Note that the use of SolarSmart™ panels will partially block heat generating infra-red solar energy, which will further assist in reducing the air-conditioning costs during summer time.

Thickness (mm)	SUNGLAZE™ U Value (W·m²·K)	Glass U Value (W·m²·K)
3	5.43	5.79
4	5.29	5.76

## Flammability

All flammability results for SUNGLAZE have been verified through 3rd party accredited testing agencies.

Test	ASTM Standard	Classification
Flammability	EN-13501	B, s1, d0
Self ignition	D-1929	628°C
Smoke density	D-2843	<75%
Burn extent	D-635	CC1
Flame spread / smoke	E-84	Class B



## Typical Physical Properties

Property	Method**	Conditions	Units	Value
<b>Mechanical</b>				
Density	D-792		g/cm <sup>3</sup>	1.2
Tensile modulus of elasticity	D-638	1 mm/min	Mpa	2,300
Flexural strength	D-790	1 mm/min	Mpa	93
Flexural modulus	D-790	1.3 mm/min	Mpa	2,600
Notched impact strength Izod	D-256	23°C	J/m	800
Impact falling dart	ISO 6603/1d	3mm	J	158
Impact - fall through	E-695		m/kg	336
Charpy Impact after Xenon Arc Exposure (D-6110)	D-2565-08	3000 hrs	% Loss of Impact Strength	<10
<b>Thermal</b>				
HDT (Heat Deflection Temperature)	D-648	Load: 1.82Mpa	°C	135
Vicat softening temperature	D-1525	Load: 1kg	°C	150
Service temperature - Short term			°C	-50 to 120
Service temperature - Long term			°C	-50 to 100
Coefficient of linear thermal expansion	D-696		cm/cm °C	6.5 x 10 <sup>-5</sup>
Thermal conductivity	C-177		W/m °K	0.21
Specific heat capacity	C-351		kJ/kg °K	1.3
<b>Weathering</b>				
Color change	D-2244	60 months	ΔE	<3
Yellowing index	E-313	60 months	Δ Yellowness Index	<10
Light transmission	D-1003	10 years	%	<6
<b>Leakage / Structural</b>				
Water leakage	E-283	20 psf		none
Air leakage	E-331		cfm/ft <sup>2</sup>	0.05
Uniform load	E-330		psf	+140 / -45

\*Properties in the table relate to the polycarbonate glazing panels in the SUNGLAZE system.

\*\*ASTM method except where noted otherwise.

## Acoustic Properties

Sunglaze panels sound insulation properties are indicated in the table to the right. The attenuation of sound waves together with its impact resistance, has made Sunglaze a material of choice for cladding.

Thickness	Acoustic Insulation DIN 52210-75 RW (db)
4mm	23
3mm	24

## Resistance to UV Radiation

Palram polycarbonate panels retain their mechanical properties and transparency throughout a long time of external service due to integrated co-extruded UV protection. The protection will not peel off over time. SUNGLAZE is offered with upper-side UV protection as standard, although a UV2 version with protection on both sides is available upon request. The attached graph presents typical results from SUNGLAZE panels tested under accelerated weathering (QUV exposure simulation) that is equivalent to 20 years of actual field exposure. The light transmission of SUNGLAZE was essentially stable.

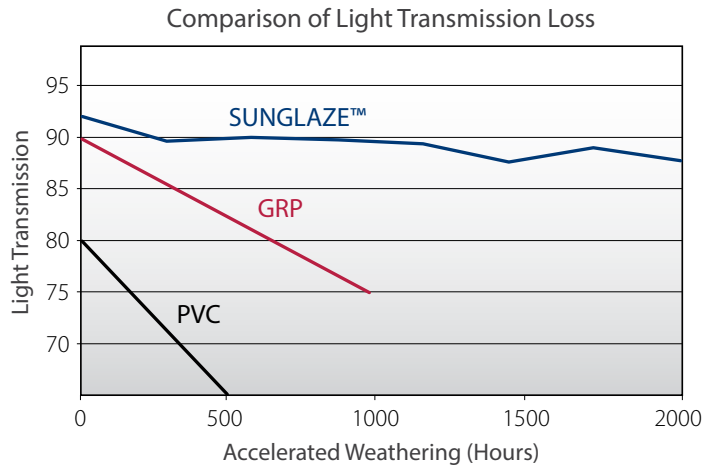

## Chemical Characteristics

To obtain a wide listing of Palram’s polycarbonate sheets resistance to chemical agents please visit Palram Australia website at [www.palram.com.au](http://www.palram.com.au) or contact your Palram distributor.

## System Principles

SUNGLAZE system components fit all panel types, except end closures 07, 08.

### Glazing Set



The Base is 65mm wide by 21 mm high, mill-finished extruded aluminum profile. Its maximum length is 6m. The Base is the lower part of the glazing set, placed under the panels and fixed to the structure by the Fixing screws.

The Cap is 53mm wide and 23mm high, mill-finished extruded aluminum profile. Its maximum length is 6m. The Cap is the upper profile of the glazing assembly, positioned onto the panel edges and Base, and attached to the Base by the Locking screws.

The Cap-Plug is 19.5mm wide aluminum strip mill-finished. Its maximum length is 6m. The Plug is clicked into place onto the Cap, concealing the Locking screws from the top, and providing a smooth surface.

### Screws



The fixing screw fix the Base to the structure and is either a cross-head self drilling screw, 4.8x19mm (10x0.75”) or a Metal SUPA LOW head 12 x 18 C3 for metal structure or a Timber wafer head 10g x 35 C3 for timber structures.

The locking screw is a cross-head tapping screw, 5.5x19mm (12x0.75”). These screws attach the Cap onto the Base and panel edges.



These are mill-finished aluminum plates that plug the two ends of the profiles assembly. 3mm End Closure is used for 3/600 panel assembly. 4mm End Closure is used for 4/600 panel and 4/800 panel assembly.

## System Components

Component	Part No.	Drawing	Suppliance Data
Base	04		Length: Up to 6m Finish: Mill/Anodized
Cap	05		Length: Up to 6m Finish: Mill/Anodized
Cap Plug	06		Length: Up to 6m Finish: Mill/Anodized
SUNGLAZE 3mm End Closure	07		Quantity: 100 Pcs/Box Finish: Mill (Natural)
SUNGLAZE 4mm End Closure	08		Quantity: 100 Pcs/Box Finish: Mill (Natural)
Fixing Screw Cross-head self-drilling screw 4.8x19mm (3/4")	09a		Quantity: 500 Pcs/Box
Fixing Screw Metal SUPA LOW head 12 x 18 C3 for metal structure	09b		Quantity: 50 Pcs/Box
Fixing Screw Timber wafer head 10g x 35 C3 for timber structures	09c		Quantity: 50 Pcs/Box
Locking Screw Cross-head tapping screw 5.5x19mm (3/4")	10		Quantity: 500 Pcs/Box

# Installation Data

## Roof structure

SUNGLAZE system is designed for both rafter and purlin construction options, flat or curved. The recommended minimum roof slope for SUNGLAZE applications is 5%. For lower slopes - rafter design is recommended.

## Assembled System Width

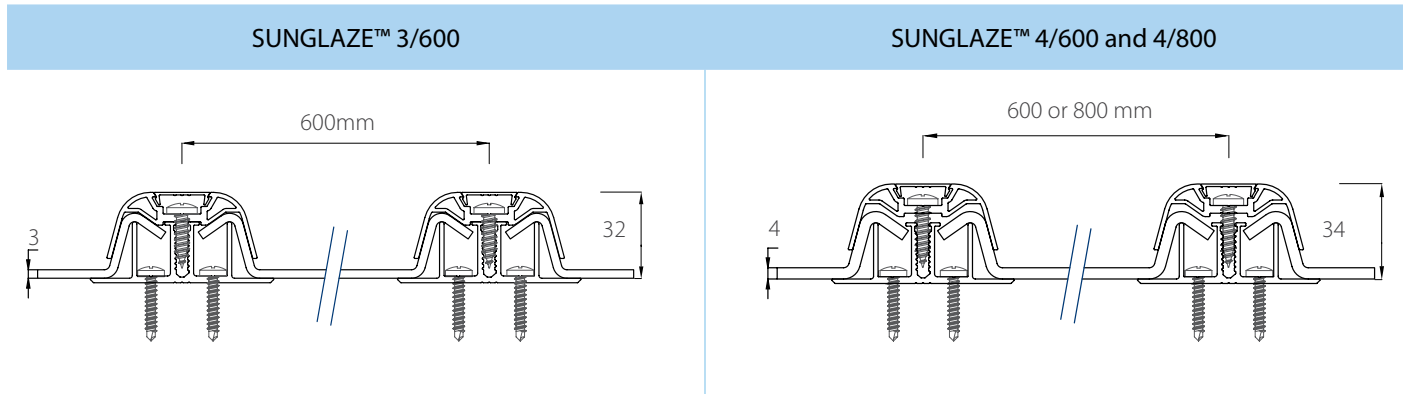

## Maximum Spans Between Purlins

Type	Rafter Centers	Single Span (mm)					
		75 kg/m <sup>2</sup>	100 kg/m <sup>2</sup>	125 kg/m <sup>2</sup>	150 kg/m <sup>2</sup>	175 kg/m <sup>2</sup>	200 kg/m <sup>2</sup>
3/600	600	900	820	760	NA	NA	NA
4/600	600	900	820	760	720	680	NA
4/800	800	820	745	690	NA	NA	NA

Type	Rafter Centers	Multi-Span											
		Mid-Span (mm)						End-Span (mm)					
		75 kg/m <sup>2</sup>	100 kg/m <sup>2</sup>	125 kg/m <sup>2</sup>	150 kg/m <sup>2</sup>	175 kg/m <sup>2</sup>	200 kg/m <sup>2</sup>	75 kg/m <sup>2</sup>	100 kg/m <sup>2</sup>	125 kg/m <sup>2</sup>	150 kg/m <sup>2</sup>	175 kg/m <sup>2</sup>	200 kg/m <sup>2</sup>
3/600	600	1540	1400	1300	NA	NA	NA	1210	1100	1020	NA	NA	NA
4/600	600	1540	1400	1300	1220	1160	1110	1210	1100	1020	960	910	870
4/800	800	1400	1275	1180	NA	NA	NA	1100	1000	925	NA	NA	NA

### Notes:

1. The values are based on, maximal deflection criterion of L/200 for the aluminum profiles and L/20 for the Polycarbonate panels.
2. The dimensions depicted do not supersede the requirements of local construction codes.
3. In case of installation with supports by rafters, the distance between screws should be 800 mm.

# Assembly Details

**Please note:** All drawings are available as CAD files from [www.palram.com](http://www.palram.com).

## Wall - Roof detail

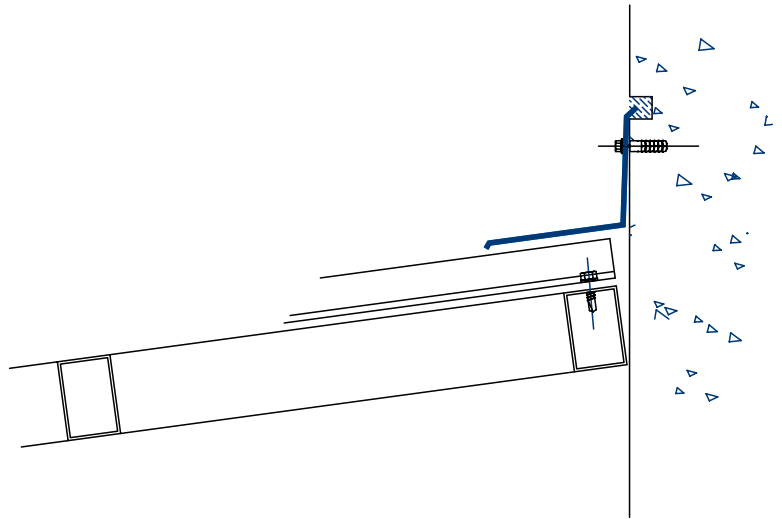

## Gutter detail

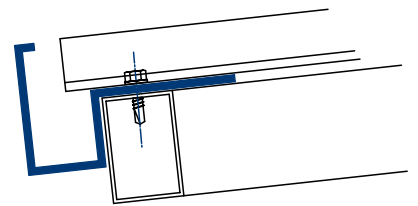

## Ridge Cap detail

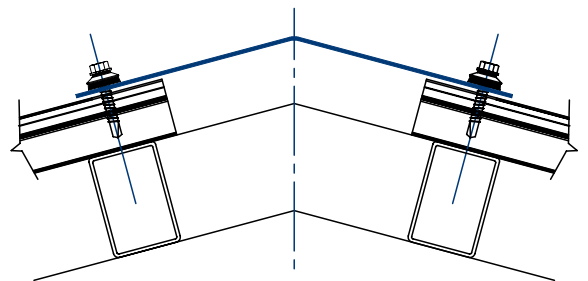

## Side flashing

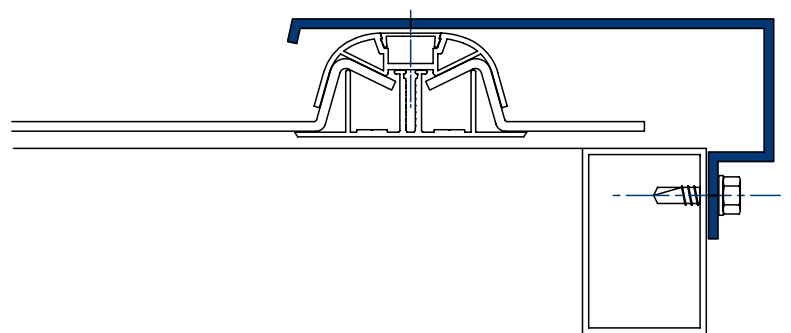

# Installation Guidelines

**1** Cut to size

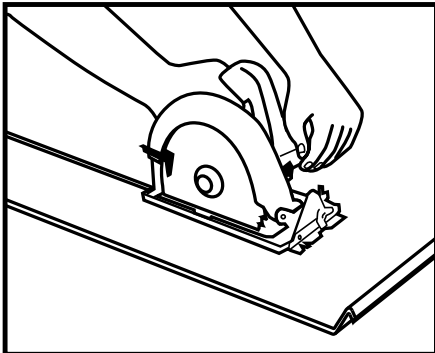

**2** Install base

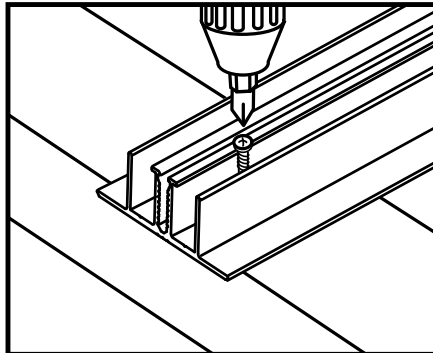

**3** Next base positioning

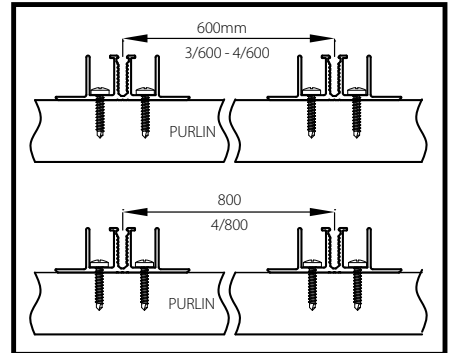

**4** Remove inner masking

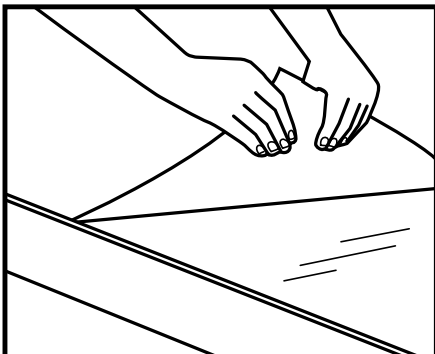

**5** Position the Panels

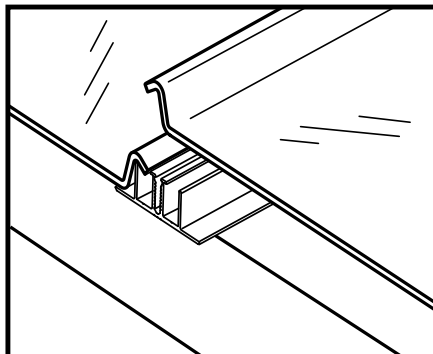

**6** Fix Cap

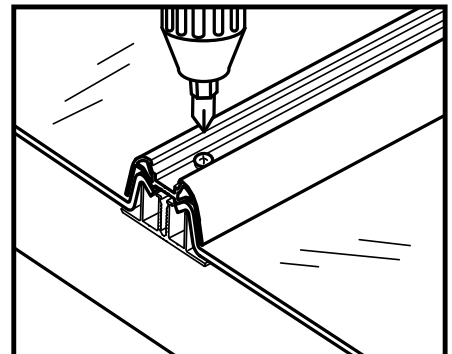

**7** Assemble Cap Plug

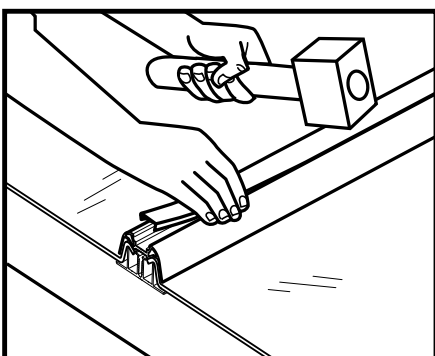

**8** Fix End Cap

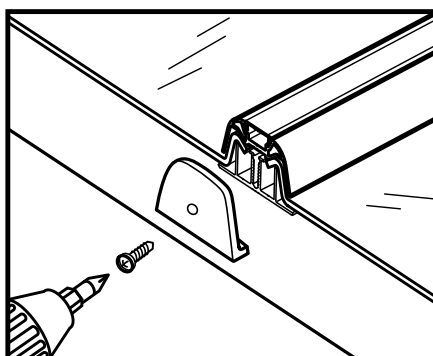

**9** Remove outer masking

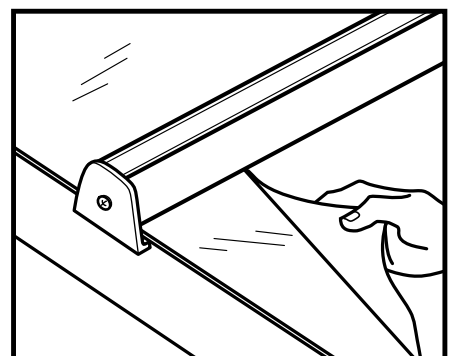

### 1. Cut to size (Fig. 1)

Cut Alu-profiles to length, allowing for overhangs of up to 100mm at each end. An overhang of minimum 50mm over the end-purlin into the gutter is recommended. Cut panels to length, 20mm shorter than Alu-profiles for expansion allowance. Use a circular saw or hand saw with fine tooth blades and moderate feeding rate for easier and finer cutting.

### 2. Fix base profile (Fig. 2)

Set the first base profile at the precise center line of the supporting structure, and fix it to the structure using the provided fixing screws.

**Purlin:** Fix screw at each purlin base junction on both sides of base (two screws for every junction).

**Rafter:** Screws centers should be 450mm center and alternating sides.

**Curved:** Locate the fixing screws on both sides of base - two screws for every junction between base and purlin.

**Note: In high wind areas and cyclonic regions fixing screws need to be both sides of base to structure. This is also recommended for flat applications .**

### 3. Fix next base profile (Fig. 3)

Locate center line of next base profile at 600mm (for 3/600 and 4/600) or 800mm (for 4/800) from prior base center line, and fix it as describe in step 2.

**IMPORTANT!** measure and mark the Base center line at every purlin, or at every screw location on a rafter. It is highly advisable to prepare and use a spacer rod. (Note: in order to avoid piling up of deviations, do not fix more than 1-2 base profiles ahead of actual assembly).

### 4. Remove inner masking (Fig. 4)

Remove the protective masking from the panel back surface (the face to contact the purlins). Keep this side away from the roof purlins until final positioning of the panel, to avoid scratching.

### 5. Position panels (Fig. 5)

Position the panels onto the bases. Make sure the panels are correctly seated along their whole length.

### 6. Lock cap (Fig. 6)

Position Cap onto the base and panels edges. Pre-drill 5mm holes along the positioning groove every 250mm, it is recommended to safely perform pre-drilling in advance on the ground). Fix the Cap with locking screws through the pre-drilled holes and into to the base profile. The screws on both ends of the cap should be located 50mm from each profile end.

### 7. Insert cap plug (Fig. 7)

Click Cap Plug into place on top of the Cap using a rubber mallet, performing moderate strikes with short intervals.

### 8. Fix end closure (Fig. 8)

Fix End Closure at the bottom end of the Alu profiles (gutter end).

### 9. Remove outer masking (Fig. 9)

Remove the protective masking from the panel's external face shortly after installation. Delaying removal of the masking can make it very difficult to remove later. (Note: on hot days remove top protective film immediately after installation to prevent film from bonding to the panel!)

### 10. Repeat stages 3 to 9.

### 11. Cut side panels to size

Determine width of the required side panels and cut to size. Use a circular saw or hand saw with fine tooth blades with moderate feeding rate for easier and finer cutting.

### 12. Side flashings

These are purpose made flashings (by others), and used on the structure sides, as a fastener as well as a flashing, when end panels width is cut to size.

#### Notes:

1. SUNGLAZE system does not require using silicones or adhesives for parts interface. For sealing of flashing assemblies use only Palram approved accessories, silicones, sealing tape, closure fixtures etc.

2. To clean SUNGLAZE panels, use a pressure washer with a fanned spray nozzle and allow natural drying. Do not use cloth, sponge, chamois or similar accessories. Doing this might scratch the panels and harm their appearance.

## Manufacturer's Lifetime Warranty

SUNGLAZE panels are guaranteed for water leak-proof performance for 25 years. SUNGLAZE panels bear a limited lifetime warranty not to lose more than 6% of light transmission for 10 years and no more than 1% per year thereafter, when measured according to ASTM D1003-77. SUNGLAZE panels are warranted for up to 10 years from the date of purchase not to break or fail as a result of impact by hail measuring up to 20mm in diameter, in speed of up to 21m/s.

**Please note:** Warranties only apply to installations and maintenance that follow Palram installation instructions and specifications.

02/2015 The data in this publication supersedes previous releases. For the latest update refer to our website: [www.palram.com.au](http://www.palram.com.au)

All marketing materials and any content therewith provided by Palram® are provided solely for the purpose of supporting and enhancing the marketing of Palram® products. These materials are protected by Palram's intellectual property rights and may not be used for any other purpose or in connection with the sale of products of any other manufacturer. These materials may not be transferred to or used by any third party without prior permission of Palram.



### PALRAM SA/NT

517A Cross keys Road  
Cavan SA 5094  
Tel: (08) 8262 2288  
Fax: (08) 8262 3388  
[salessa@palram.com](mailto:salessa@palram.com)

### PALRAM NSW/ACT

Unit 2/26 Redfern Street  
Wetherill Park NSW 2164  
Tel: (02) 8788 6100  
Fax: (02) 8788 6199  
[salesnsw@palram.com](mailto:salesnsw@palram.com)

### PALRAM QLD

Unit 9C / 380 Bilsen Road  
Geebung QLD 4034  
Tel: (07) 3172 5581  
Fax: (07) 3172 5516  
[salesqld@palram.com](mailto:salesqld@palram.com)

### PALRAM VIC/TAS

34 Buys Court  
Derrimut VIC 3030  
Tel: (03) 9219 4444  
Fax: (03) 9219 4455  
[salesvic@palram.com](mailto:salesvic@palram.com)

### PALRAM WA

74 Christable Way  
Landsdale WA 6065  
Tel: (08) 9302 4173  
Fax: (08) 9302 5287  
[saleswa@palram.com](mailto:saleswa@palram.com)



06.2016

In as much as Palram Industries has no control over the use to which others may put the material, it does not guarantee that the same results as those described herein will be obtained. Each user of the material should make his own tests to determine the material's suitability for his own particular use. Statements concerning possible or suggested uses of the materials described herein are not to be construed as constituting a license under any Palram Industries patent covering such use or as recommendations for use of such materials in the infringement of any patent. Palram Industries or its distributors cannot be held responsible for any losses incurred through incorrect installation of the material. In accordance with our company policy of continual product development you are advised to check with your local Palram Industries supplier to ensure that you have obtained the most up to date information.

©2008 Palram Industries Ltd. | SUNGLAZE is trademark of Palram Industries Ltd.



[www.palram.com.au](http://www.palram.com.au)